



UNIVERSITY OF CAMBRIDGE INTERNATIONAL EXAMINATIONS  
General Certificate of Education Ordinary Level

**COMBINED SCIENCE**

**5129/11**

Paper 1 Multiple Choice

**October/November 2011**

**1 hour**

Additional Materials:      Multiple Choice Answer Sheet  
   Soft clean eraser  
   Soft pencil (type B or HB is recommended)



**READ THESE INSTRUCTIONS FIRST**

Write in soft pencil.

Do not use staples, paper clips, highlighters, glue or correction fluid.

Write your name, Centre number and candidate number on the Answer Sheet in the spaces provided unless this has been done for you.

There are **forty** questions on this paper. Answer **all** questions. For each question there are four possible answers **A, B, C** and **D**.

Choose the **one** you consider correct and record your choice in **soft pencil** on the separate Answer Sheet.

**Read the instructions on the Answer Sheet very carefully.**

Each correct answer will score one mark. A mark will not be deducted for a wrong answer.

Any rough working should be done in this booklet.

A copy of the Periodic Table is printed on page 20.

This document consists of **18** printed pages and **2** blank pages.



- 1 The diagram shows an instrument used in Physics.

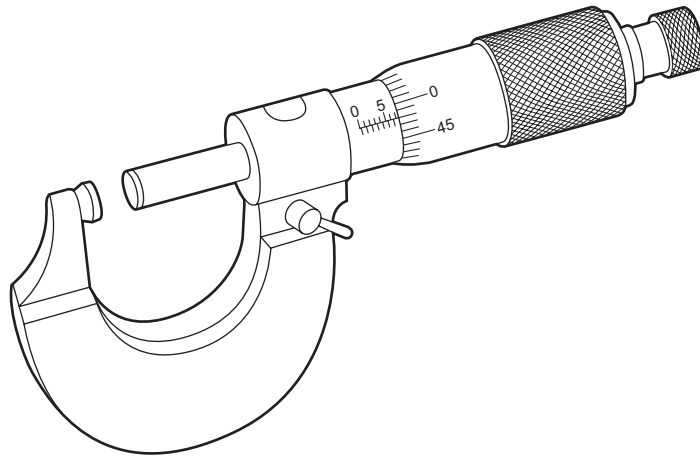

What is the name of this instrument and what is it used to measure?

	name	used to measure
<b>A</b>	calipers	length
<b>B</b>	calipers	pressure
<b>C</b>	micrometer	length
<b>D</b>	micrometer	pressure

- 2 Which car, moving from rest, has an average acceleration of  $2.0 \text{ m/s}^2$ ?

- A** a car reaching a speed of  $10 \text{ m/s}$  in  $2 \text{ s}$
- B** a car reaching a speed of  $20 \text{ m/s}$  in  $5 \text{ s}$
- C** a car reaching a speed of  $30 \text{ m/s}$  in  $10 \text{ s}$
- D** a car reaching a speed of  $40 \text{ m/s}$  in  $20 \text{ s}$

- 3 A force is applied to an object on a frictionless surface. It produces an acceleration of  $3 \text{ m/s}^2$ .

What are possible values for the applied force and for the mass of the object?

	force / N	mass / kg
<b>A</b>	2	5
<b>B</b>	2	6
<b>C</b>	5	2
<b>D</b>	6	2

- 4 In an energy transformation sequence, what produces kinetic energy from gravitational potential energy as part of the sequence?
- A burning fuel in a power station
  - B generating hydroelectric energy
  - C generating energy in a nuclear power station
  - D generating energy in a geothermal power station
- 5 A man pushes a heavy box across a floor. He exerts a force of 80 N and the box moves 4.0 m in 5.0 seconds.

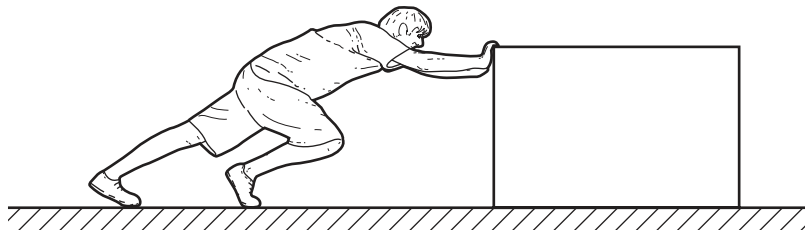

What useful power does the man develop?

- A 4.0W
  - B 64W
  - C 100W
  - D 1600W
- 6 Which property is essential to a clinical thermometer?
- A It contains mercury.
  - B It has a constriction in its bore.
  - C It has a range of 40 °C.
  - D It is accurate to 0.001 °C.

- 7 At regular intervals along a railway line there is a gap between the rail sections.

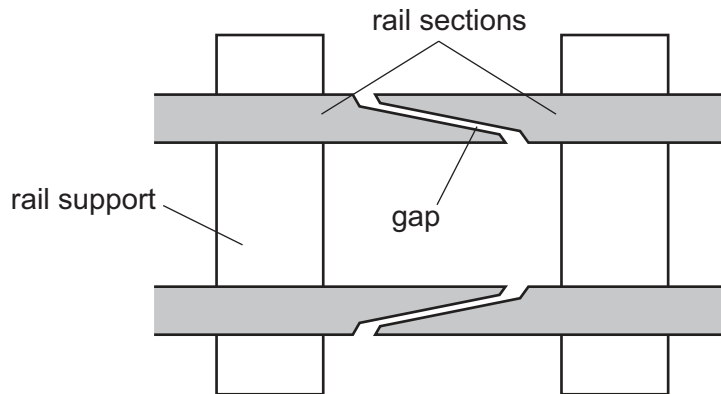

What is the reason for the gap between the rail sections?

- A to allow for expansion of the rail sections during hot weather
  - B to allow for vibrations of the rail sections as the train passes over them
  - C to allow rain water to drain from the rail sections
  - D to keep the wheels of the train and carriages on the rail sections
- 8 A VHF radio station broadcasts at a frequency of 60 MHz ( $6.0 \times 10^7$  Hz). The speed of radio waves is  $3.0 \times 10^8$  m/s.

What is the wavelength of the waves broadcast by the station?

- A 5.0 m
- B 2.0 m
- C 0.5 m
- D 0.2 m

- 9 The diagram shows the reflection of a ray of light from an object in a plane mirror.

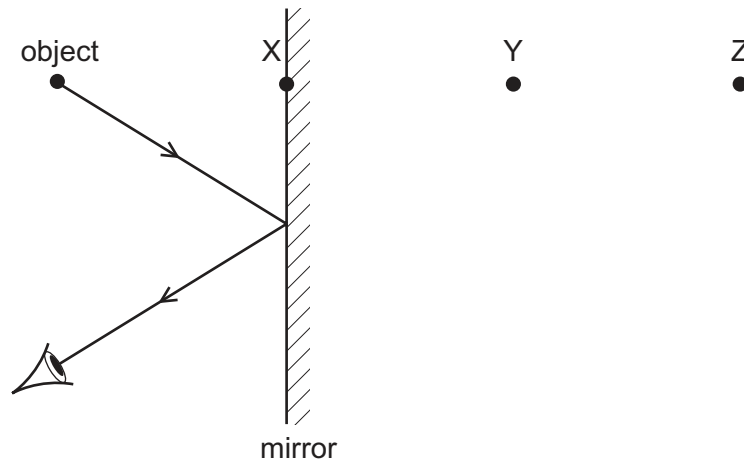

Which statement is correct?

- A The image is at X.
  - B The image is between X and Y.
  - C The image is at Y.
  - D The image is between Y and Z.
- 10 Which diagram correctly shows the directions of the electrostatic forces on a pair of charged spheres?

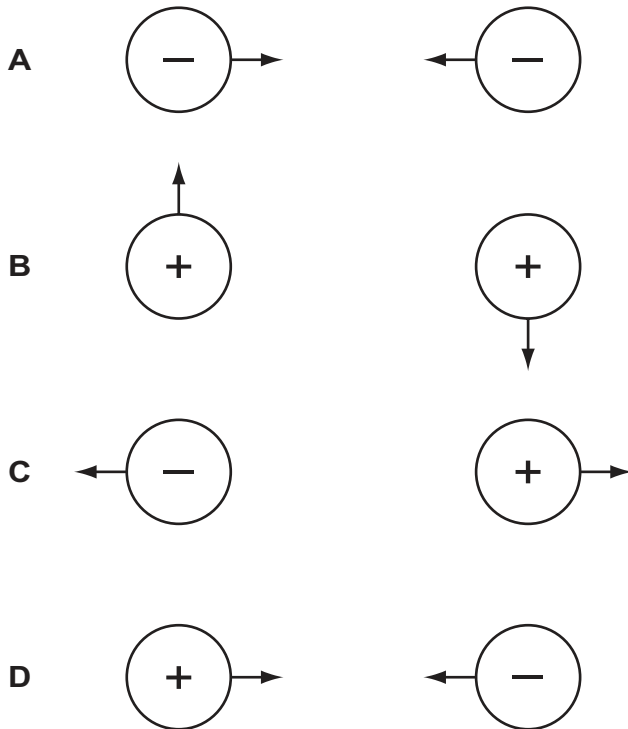

11 A constant-voltage source is connected to a resistor which has a current  $I$  through it.

Two more identical resistors are then added in series with the first.

What is the current now?

A  $\frac{I}{4}$

B  $\frac{I}{3}$

C  $I$

D  $3I$

12 The diagram shows an unsafe use of an extension cable.

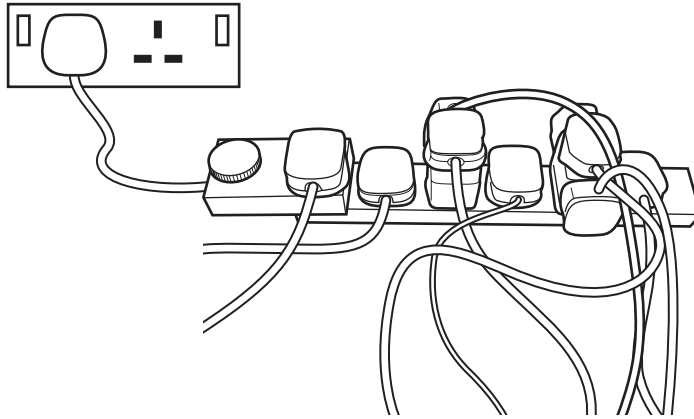

What is the electrical hazard?

- A the danger of burning out the appliances
- B the danger of melting the fuse
- C the danger of overheating the cable
- D the danger of the appliances not being earthed

- 13 The transformer in the diagram has an input coil with  $N_i$  turns and an output coil with  $N_o$  turns.

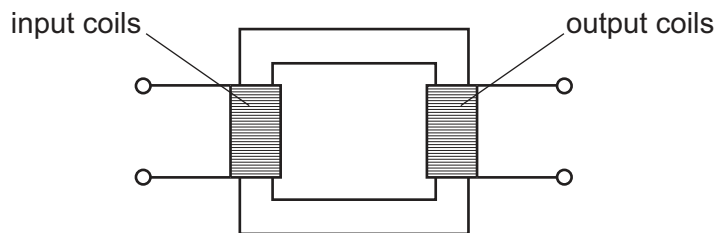

The output voltage needs to be lower than the input voltage.

What is needed for the transformer to work correctly?

	input supply	relative values of $N_i$ and $N_o$
<b>A</b>	a.c.	$N_i > N_o$
<b>B</b>	a.c.	$N_i < N_o$
<b>C</b>	d.c.	$N_i > N_o$
<b>D</b>	d.c.	$N_i < N_o$

- 14 Which piece of apparatus would be most suitable to measure accurately the volume of acid needed to neutralise  $25.0 \text{ cm}^3$  of an alkali?

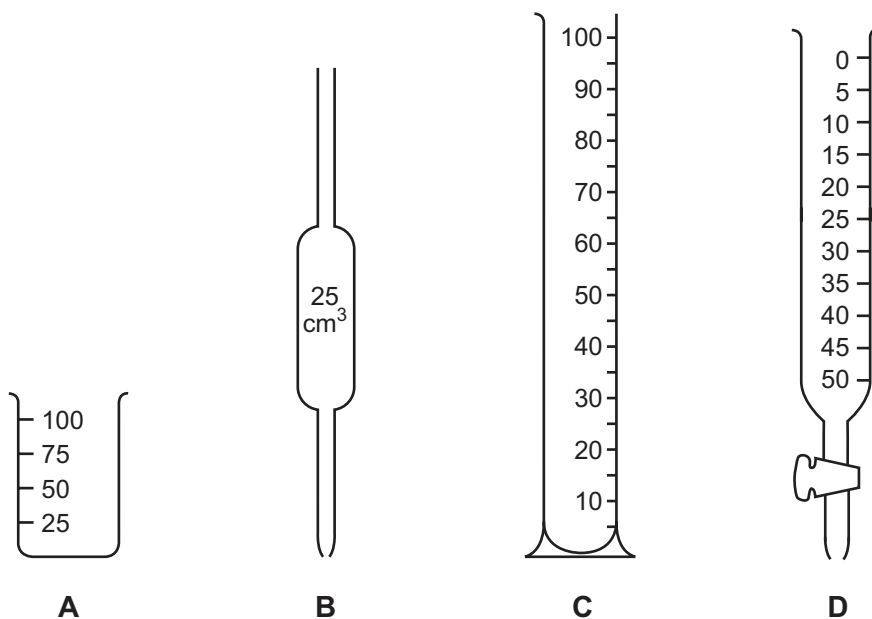

15 In which conversion do water molecules lose speed?

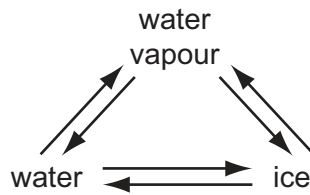

- A ice  $\rightarrow$  water
- B ice  $\rightarrow$  water vapour
- C water vapour  $\rightarrow$  ice
- D water  $\rightarrow$  water vapour

16 An atom of element X is represented by  ${}^7_3\text{X}$ .

Which statement about this atom of X is correct?

- A It is in Group III of the Periodic Table.
- B It is in Group VII of the Periodic Table.
- C The total number of protons and electrons is 6.
- D The total number of protons and neutrons is 10.

17 The table shows the electronic structures of four elements.

element	electronic structure
W	2, 6
X	2, 8
Y	2, 8, 1
Z	2, 8, 7

Which pair of atoms form a covalent molecule?

- A two atoms of W
- B two atoms of X
- C an atom of W and an atom of X
- D an atom of Y and an atom of Z



18 Which process is endothermic?

- A the formation of a hydrogen-chlorine bond
- B the formation of silver from silver salts in photography
- C the formation of water from oxygen and hydrogen
- D the formation of water from steam

19 Which statement about all acids is correct?

- A They contain both hydrogen and oxygen.
- B They give ammonia with an ammonium salt.
- C They have a pH value below 7.
- D They react with all metals to form hydrogen.

20 What are the properties of bromine?

	state at room temperature	result of adding bromine to aqueous potassium iodide
<b>A</b>	gas	no reaction
<b>B</b>	gas	reaction
<b>C</b>	liquid	no reaction
<b>D</b>	liquid	reaction

21 Which diagram represents the structure of an alloy?

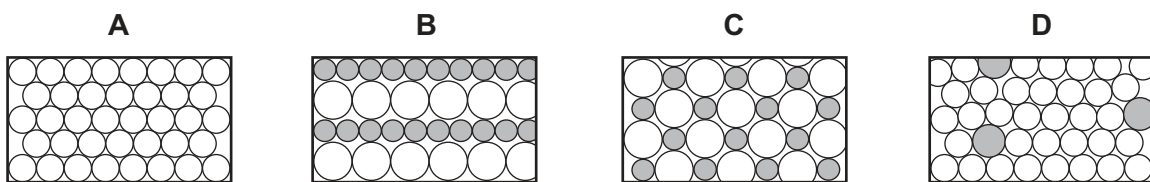

22 Water is formed when hydrogen is passed over the heated oxide of metal X.

No water is formed when hydrogen is passed over the heated oxide of metal Y.

What is the order of reactivity of hydrogen, metal X and metal Y?

	most reactive	—————>	least reactive
<b>A</b>	hydrogen	X	Y
<b>B</b>	X	hydrogen	Y
<b>C</b>	X	Y	hydrogen
<b>D</b>	Y	hydrogen	X

23 Aluminium is used to make saucepans because of its apparent lack of reactivity.

Which property of aluminium explains its unreactivity?

- A** It has a high electrical conductivity.
- B** It has a layer of oxide on its surface.
- C** It has a low density.
- D** It is in Group III of the Periodic Table.

24 Ammonia may be obtained from ammonium chloride by heating with

- A** aqueous calcium chloride.
- B** aqueous sodium hydroxide.
- C** dilute hydrochloric acid.
- D** water.

25 The table shows the boiling point ranges of fractions collected from distillation of a sample of petroleum (crude oil).

Which fraction contains the smallest molecules?

fraction	boiling point range
<b>A</b>	20 – 50°C
<b>B</b>	50 – 100°C
<b>C</b>	100 – 150°C
<b>D</b>	150 – 250°C

26 Which is the molecular formula of an alkane?

- A  $C_3H_6$                       B  $C_4H_{10}$                       C  $C_6H_{12}$                       D  $C_7H_{18}$

27 Which substance can be oxidised to form ethanoic acid?

- A  $CH_3OH$                       B  $C_2H_5OH$                       C  $C_3H_7OH$                       D  $C_4H_9OH$

28 The diagram shows a plant cell.

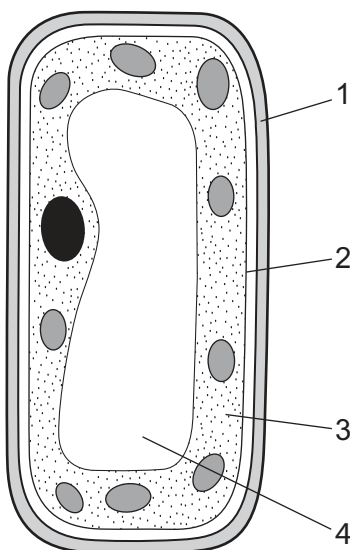

Which structures are the cell membrane, cell wall and cytoplasm?

	cell membrane	cell wall	cytoplasm
<b>A</b>	1	2	3
<b>B</b>	1	2	4
<b>C</b>	2	1	3
<b>D</b>	2	1	4

29 The diagram shows a root hair, surrounded by a dilute solution of mineral ions.

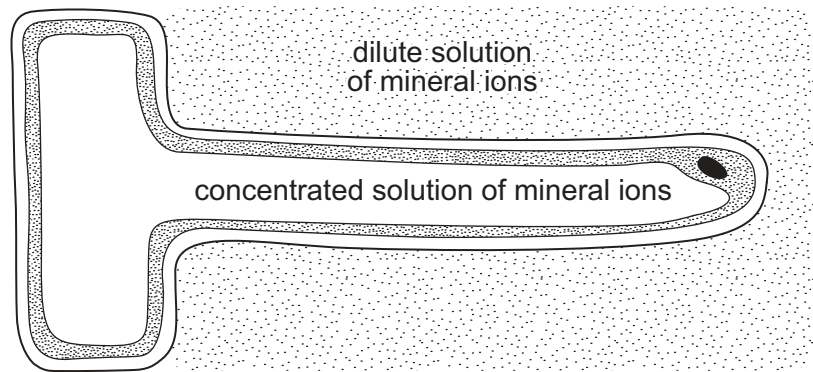

Which statement describes what happens?

- A Water molecules move into the root hair because their concentration is lower inside.
- B Water molecules move into the root hair because their concentration is lower outside.
- C Water molecules move out of the root hair because their concentration is lower inside.
- D Water molecules move out of the root hair because their concentration is lower outside.



32 To investigate whether bacteria in the mouth produce acids, a student

- rubbed two pieces of sterile cotton wool on his teeth,
- dipped only one of these pieces into finely powdered sugar,
- left both pieces in separate petri dishes for thirty minutes,
- covered both pieces with Universal Indicator solution.

[Universal Indicator solution colours: above pH 7, dark green to blue; pH 6-7, green; below pH 6, yellow to red]

Which colours will be observed at the end of the experiment?

	sample dipped into sugar	sample not dipped into sugar
<b>A</b>	green	green
<b>B</b>	green	red
<b>C</b>	red	green
<b>D</b>	red	red

33 The diagram represents part of the human circulatory system.

Where is the blood pressure highest?

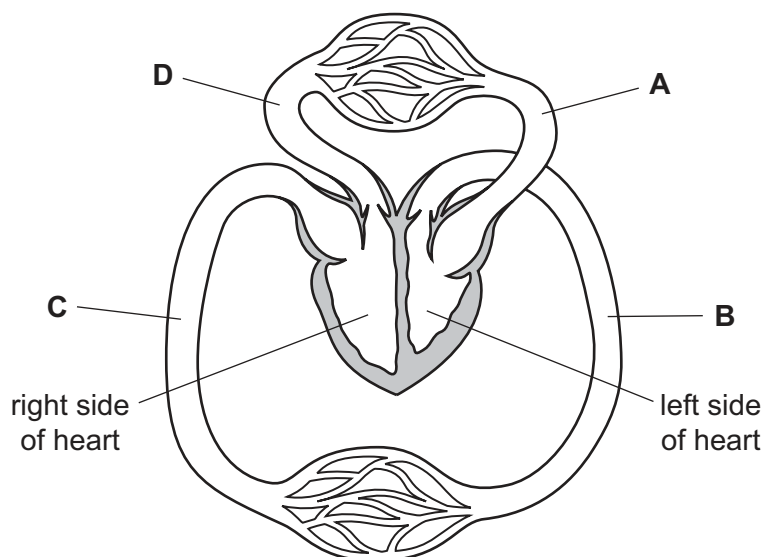

- 34 Which equation represents anaerobic respiration in yeast?
- A glucose  $\rightarrow$  alcohol + carbon dioxide  
 B glucose  $\rightarrow$  alcohol + water  
 C glucose  $\rightarrow$  lactic acid + carbon dioxide  
 D glucose  $\rightarrow$  lactic acid + water
- 35 What is the excretory product in blood that is removed by the lungs?
- A carbon dioxide  
 B lactic acid  
 C urea  
 D water
- 36 The diagram shows a section through a human eye.

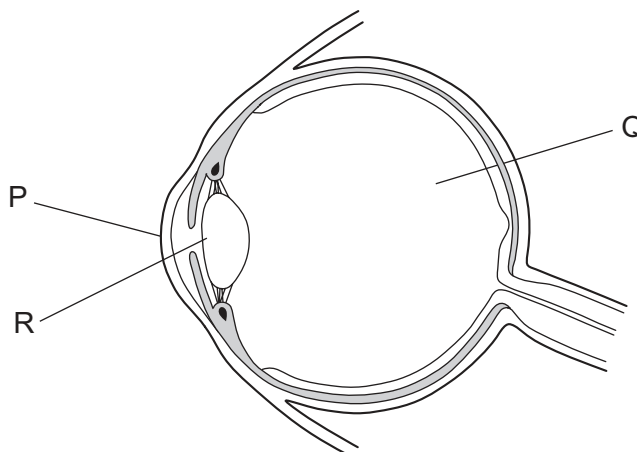

The eye produces an image by refracting (bending) light onto the retina.

How much of this refraction is created by the parts P, Q and R?

	most refraction	some refraction	no refraction
<b>A</b>	P	Q	R
<b>B</b>	P	R	Q
<b>C</b>	R	P	Q
<b>D</b>	R	Q	P

37 The diagram shows a food web.

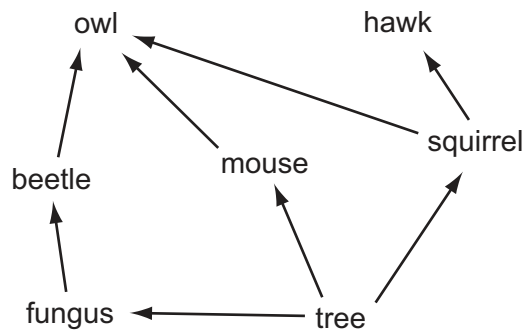

Which of the organisms, shown in the food web, can survive by taking in only simple inorganic materials?

- A beetle
- B fungus
- C owl
- D tree

38 Cutting down large areas of tropical forest can lead to a reduction in rainfall.

What is the reason for the reduction in rainfall?

- A a reduction in photosynthesis
- B a reduction in transpiration
- C an increase in flooding
- D an increase in respiration



39 The diagram shows a flower in longitudinal section.

Before they had developed fully, a plant breeder removed the structures labelled X, as shown.

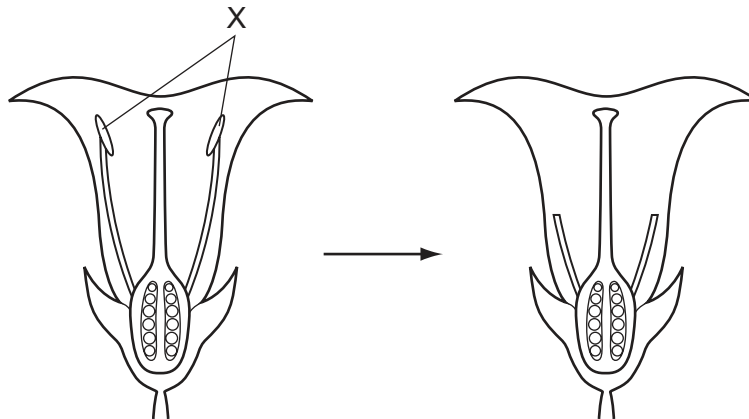

What is the effect of removing these structures?

- A It prevents asexual reproduction.
  - B It prevents the flower from being pollinated.
  - C It prevents the flower from producing seeds.
  - D It prevents the flower from pollinating itself.
- 40 What is a method of preventing the spread of HIV?
- A avoiding sharing cups for drinking
  - B checking blood before transfusions
  - C taking the contraceptive pill
  - D using spermicides



**BLANK PAGE**

**DATA SHEET**  
**The Periodic Table of the Elements**

		Group																																																																																												
I	II	III	IV	V	VI	VII	0																																																																																							
7 <b>Li</b> Lithium 3	9 <b>Be</b> Beryllium 4	1 <b>H</b> Hydrogen 1	11 <b>B</b> Boron 5	12 <b>C</b> Carbon 6	14 <b>N</b> Nitrogen 7	16 <b>O</b> Oxygen 8	19 <b>F</b> Fluorine 9	20 <b>Ne</b> Neon 10	23 <b>Na</b> Sodium 11	24 <b>Mg</b> Magnesium 12	27 <b>Al</b> Aluminium 13	28 <b>Si</b> Silicon 14	31 <b>P</b> Phosphorus 15	32 <b>S</b> Sulfur 16	35.5 <b>Cl</b> Chlorine 17	40 <b>Ar</b> Argon 18	39 <b>K</b> Potassium 19	40 <b>Ca</b> Calcium 20	45 <b>Sc</b> Scandium 21	48 <b>Ti</b> Titanium 22	51 <b>V</b> Vanadium 23	52 <b>Cr</b> Chromium 24	55 <b>Mn</b> Manganese 25	56 <b>Fe</b> Iron 26	59 <b>Co</b> Cobalt 27	59 <b>Ni</b> Nickel 28	64 <b>Cu</b> Copper 29	65 <b>Zn</b> Zinc 30	70 <b>Ga</b> Gallium 31	73 <b>Ge</b> Germanium 32	75 <b>As</b> Arsenic 33	79 <b>Se</b> Selenium 34	80 <b>Br</b> Bromine 35	84 <b>Kr</b> Krypton 36	85 <b>Rb</b> Rubidium 37	88 <b>Sr</b> Strontium 38	89 <b>Y</b> Yttrium 39	91 <b>Zr</b> Zirconium 40	93 <b>Nb</b> Niobium 41	96 <b>Mo</b> Molybdenum 42	101 <b>Ru</b> Ruthenium 44	106 <b>Pd</b> Palladium 46	112 <b>Cd</b> Cadmium 48	115 <b>In</b> Indium 49	119 <b>Sn</b> Tin 50	122 <b>Sb</b> Antimony 51	127 <b>I</b> Iodine 53	131 <b>Xe</b> Xenon 54	133 <b>Cs</b> Caesium 55	137 <b>Ba</b> Barium 56	139 <b>La</b> Lanthanum 57	178 <b>Hf</b> Hafnium 72	181 <b>Ta</b> Tantalum 73	184 <b>W</b> Tungsten 74	190 <b>Os</b> Osmium 76	192 <b>Ir</b> Iridium 77	195 <b>Pt</b> Platinum 78	197 <b>Au</b> Gold 79	201 <b>Hg</b> Mercury 80	204 <b>Tl</b> Thallium 81	207 <b>Pb</b> Lead 82	209 <b>Bi</b> Bismuth 83	210 <b>Po</b> Polonium 84	210 <b>At</b> Astatine 85	210 <b>Rn</b> Radon 86	226 <b>Ra</b> Radium 88	227 <b>Ac</b> Actinium 89	232 <b>Th</b> Thorium 90	232 <b>Pa</b> Protactinium 91	238 <b>U</b> Uranium 92	238 <b>Np</b> Neptunium 93	238 <b>Pu</b> Plutonium 94	238 <b>Am</b> Americium 95	238 <b>Cm</b> Curium 96	238 <b>Bk</b> Berkelium 97	238 <b>Cf</b> Californium 98	238 <b>Es</b> Einsteinium 99	238 <b>Fm</b> Fermium 100	238 <b>Md</b> Mendelevium 101	238 <b>No</b> Nobelium 102	238 <b>Lr</b> Lawrencium 103	140 <b>Ce</b> Cerium 58	141 <b>Pr</b> Praseodymium 59	144 <b>Nd</b> Neodymium 60	147 <b>Pm</b> Promethium 61	150 <b>Sm</b> Samarium 62	152 <b>Eu</b> Europium 63	157 <b>Gd</b> Gadolinium 64	162 <b>Dy</b> Dysprosium 66	165 <b>Ho</b> Holmium 67	167 <b>Er</b> Erbium 68	169 <b>Tm</b> Thulium 69	173 <b>Yb</b> Ytterbium 70	175 <b>Lu</b> Lutetium 71

\*58-71 Lanthanoid series  
†90-103 Actinoid series

a	<b>X</b>
b	

Key

a = relative atomic mass  
X = atomic symbol  
b = proton (atomic) number

The volume of one mole of any gas is 24 dm<sup>3</sup> at room temperature and pressure (r.t.p.).

Permission to reproduce items where third-party owned material protected by copyright is included has been sought and cleared where possible. Every reasonable effort has been made by the publisher (UCLES) to trace copyright holders, but if any items requiring clearance have unwittingly been included, the publisher will be pleased to make amends at the earliest possible opportunity.

University of Cambridge International Examinations is part of the Cambridge Assessment Group. Cambridge Assessment is the brand name of University of Cambridge Local Examinations Syndicate (UCLES), which is itself a department of the University of Cambridge.